



POWERING INNOVATION THAT DRIVES HUMAN ADVANCEMENT

© 2025 ANSYS, Inc. or its affiliated companies  
Unauthorized use, distribution, or duplication is prohibited.

# Getting Started with HFSS™: Skin Depth Seeding



ANSYS, Inc.  
Southpointe  
2600 Ansys Drive  
Canonsburg, PA 15317  
[ansysinfo@ansys.com](mailto:ansysinfo@ansys.com)  
<https://www.ansys.com>  
(T) 724-746-3304  
(F) 724-514-9494

Release 2025 R2  
July 2025

ANSYS, Inc. and ANSYS  
Europe, Ltd. are UL registered  
ISO 9001:2015 companies.

## Copyright and Trademark Information

© 1986-2025 ANSYS, Inc. Unauthorized use, distribution or duplication is prohibited.

ANSYS, Ansys Workbench, AUTODYN, CFX, FLUENT and any and all ANSYS, Inc. brand, product, service and feature names, logos and slogans are registered trademarks or trademarks of ANSYS, Inc. or its subsidiaries located in the United States or other countries. ICM CFD is a trademark used by ANSYS, Inc. under license. All other brand, product, service and feature names or trademarks are the property of their respective owners. FLEXIm and FLEXnet are trademarks of Flexera Software LLC.

## Disclaimer Notice

THIS ANSYS SOFTWARE PRODUCT AND PROGRAM DOCUMENTATION INCLUDE TRADE SECRETS AND ARE CONFIDENTIAL AND PROPRIETARY PRODUCTS OF ANSYS, INC., ITS SUBSIDIARIES, OR LICENSORS. The software products and documentation are furnished by ANSYS, Inc., its subsidiaries, or affiliates under a software license agreement that contains provisions concerning non-disclosure, copying, length and nature of use, compliance with exporting laws, warranties, disclaimers, limitations of liability, and remedies, and other provisions. The software products and documentation may be used, disclosed, transferred, or copied only in accordance with the terms and conditions of that software license agreement.

ANSYS, Inc. and ANSYS Europe, Ltd. are UL registered ISO 9001: 2015 companies.

## U.S. Government Rights

For U.S. Government users, except as specifically granted by the ANSYS, Inc. software license agreement, the use, duplication, or disclosure by the United States Government is subject to restrictions stated in the ANSYS, Inc. software license agreement and FAR 12.212 (for non-DOD licenses).

## Third-Party Software

See the legal information in the product help files for the complete Legal Notice for Ansys proprietary software and third-party software. If you are unable to access the Legal Notice, please contact ANSYS, Inc.

## Conventions Used in this Guide

Please take a moment to review how instructions and other useful information are presented in this documentation.

- Procedures are presented as numbered lists. A single bullet indicates that the procedure has only one step.
- Bold type is used for the following:
  - Keyboard entries that should be typed in their entirety exactly as shown. For example, “**copy file1**” means you must type the word **copy**, then type a space, and then type **file1**.
  - On-screen prompts and messages, names of options and text boxes, and menu commands. Menu commands are often separated by greater than signs (>). For example, “click **HFSS > Excitations > Assign > Wave Port.**”
  - Labeled keys on the computer keyboard. For example, “Press **Enter**” means to press the key labeled **Enter**.
- Italic type is used for the following:
  - Emphasis.
  - The titles of publications.
  - Keyboard entries when a name or a variable must be typed in place of the words in italics. For example, “**copy filename**” means you must type the word **copy**, then type a space, and then type the name of the file.
- The plus sign (+) is used between keyboard keys to indicate that you should press the keys at the same time. For example, “Press Shift+F1” means to press the **Shift** key and, while holding it down, press the **F1** key also. You should always depress the modifier key or keys first (for example, Shift, Ctrl, Alt, or Ctrl+Shift), continue to hold it/them down, and then press the last key in the instruction.

**Accessing Commands:** *Ribbons*, *menu bars*, and *shortcut menus* are three methods that can be used to see what commands are available in the application.

- The *Ribbon* occupies the rectangular area at the top of the application window and contains multiple tabs. Each tab has relevant commands that are organized, grouped, and labeled. An example of a typical user interaction is as follows:

"Click **Draw > Line**"



This instruction means that you should click the **Line** command on the **Draw** ribbon tab. An image of the command icon, or a partial view of the ribbon, is often included with the instruction.

- The *menu bar* (located above the ribbon) is a group of the main commands of an application arranged by category such File, Edit, View, Project, etc. An example of a typical user interaction is as follows:

"On the **File** menu, click the **Open Examples** command" means you can click the **File** menu and then click **Open Examples** to launch the dialog box.

- Another alternative is to use the *shortcut menu* that appears when you click the right-mouse button. An example of a typical user interaction is as follows:

"Right-click and select **Assign Excitation > Wave Port**" means when you click the right-mouse button with an object face selected, you can execute the excitation commands from the shortcut menu (and the corresponding sub-menus).

### Getting Help: Ansys Technical Support

For information about Ansys Technical Support, go to the Ansys corporate Support website, <http://www.ansys.com/Support>. You can also contact your Ansys account manager in order to obtain this information.

All Ansys software files are ASCII text and can be sent conveniently by e-mail. When reporting difficulties, it is extremely helpful to include very specific information about what steps were taken or what stages the simulation reached, including software files as applicable. This allows more rapid and effective debugging.

### Help Menu

To access help from the Help menu, click **Help** and select from the menu:

- **[product name] Help** - opens the contents of the help. This help includes the help for the product and its *Getting Started Guides*.
- **[product name] Scripting Help** - opens the contents of the *Scripting Guide*.
- **[product name] Getting Started Guides** - opens a topic that contains links to Getting Started Guides in the help system.

### Context-Sensitive Help

To access help from the user interface, press **F1**. The help specific to the active product (design type) opens.

You can press **F1** while the cursor is pointing at a menu command or while a particular dialog box or dialog box tab is open. In this case, the help page associated with the command or open dialog box is displayed automatically.

# Table of Contents

<b>Table of Contents</b> .....	<b>Contents-1</b>
<b>1 - Introduction</b> .....	<b>1-1</b>
What Is Skin Depth Seeding? .....	1-1
Why Use Seeding? .....	1-4
Skin Depth Seeding Implementation Change .....	1-5
Layered Elements Implementation .....	1-6
General Guidance for Skin Depth Based Refinement .....	1-7
Guidance for HFSS for Skin Depth Based Refinement .....	1-13
User Inputs for Skin Depth Based Refinement .....	1-13
Generate Initial Mesh .....	1-15
<b>2 - Skin Depth Mesh Plot Visualization</b> .....	<b>2-1</b>
Using a Clip Plane to View the Internal Mesh .....	2-4
Viewing Mesh Feedback to Critique the Internal Mesh .....	2-7
Selecting and Viewing Specific Faces .....	2-10
Selecting Triangles for a Face .....	2-12
Selecting Segments for a Face .....	2-12
Viewing Triangles and Segments at the Same Time .....	2-13
Changing Settings in Response to Success Rates and Visualization .....	2-14



# 1 - Introduction

This *Getting Started Guide* describes how to use Skin Depth Seeding in Ansys Electronics Desktop.

This guide answers the following questions:

- What is Skin Depth seeding?
- Why use seeding?

It also covers the following topics:

- Skin Depth mesh plot visualization
- Improvement compared to older implementation
- Using simple models
- Choosing settings

This guide does not discuss when a user should use Skin Depth Seeding.

## What Is Skin Depth Seeding?

Skin Depth seeding is a mesh operation feature of solvers that use the 3D Modeler, including HFSS and Maxwell 3D.

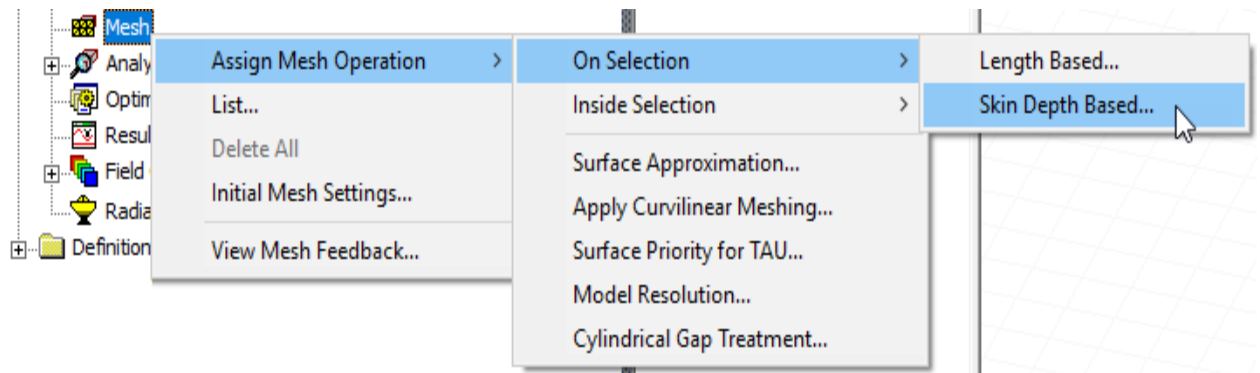

The *Length Based* mesh operations refine the specified objects or surfaces. *Skin Depth Based* mesh refinement lets you calculate or specify a skin depth for mesh refinement, as well as the number of layers of elements to generate within the specified skin depth.

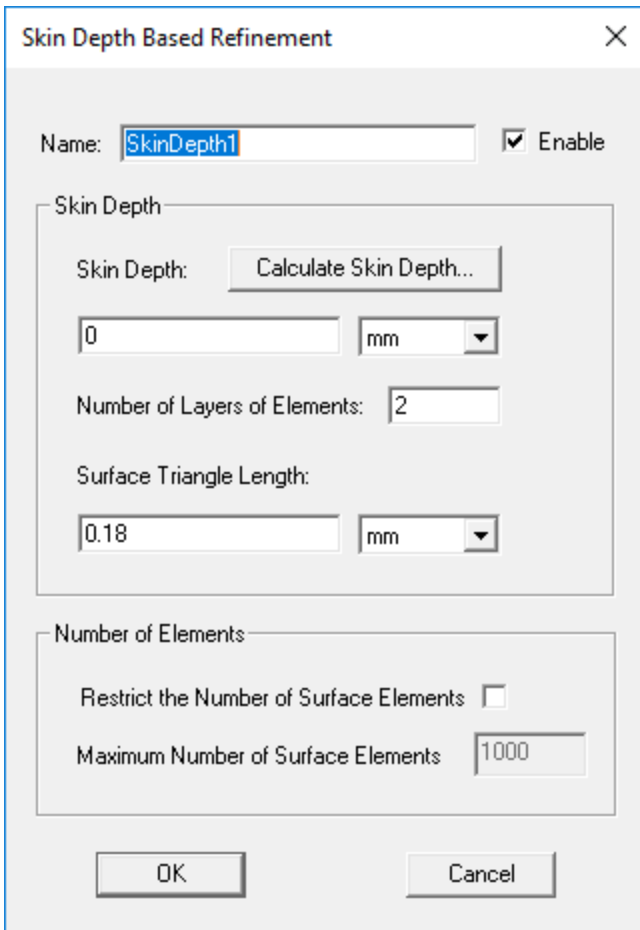

The skin depth is the total depth of all layers combined. The Skin Depth setting provides an easy, alternative approach to creating physical models of each layer using pseudo-sheet bodies. Creating and adjusting a complex, layered physical model is difficult. Correcting errors is difficult. But changing the skin depth, surface triangle length, and the number of layers is simple and has a quick turnaround time. With Skin Depth refinement, the model itself is much easier to adjust.

For example, consider a rotor, drawn as a stack of seven objects:

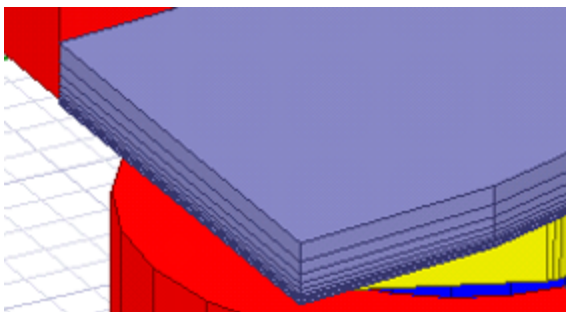

Skin Depth Layering on a single object can provide comparable or superior accuracy in the solution, and is much easier to create and adjust:

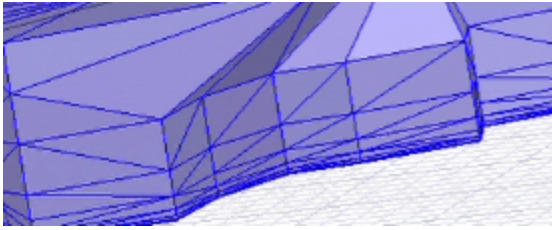

To test various stackings with the Skin Depth Layering Method for Mesh Seeding:

- Revert to initial mesh
- Change settings
- Apply mesh ops

To test various stackings using a pseudo body method:

- Recreate the model with different body thicknesses
- Remake the entire initial mesh
- Tau mesher might not be available for all heights

Skin Depth Layering is much easier and faster. In both cases, remember that a layered mesh or pseudo body modeling is a means to a good solution, not a goal in itself. Using layered elements for relevant designs is one way to get to a good solution.

For example, where a pseudo model design had 85K tets, the following table shows some different results where the Surface Triangle Length target is given different values.

Tri length target mm	Total skin depth mm	Number of layers	Mesh Size element count	Perfect layering by tri count	Perfect layering by area
15.0	6.3	6	63K	43%	65%
10.0	6.3	6	68K	95%	94%
8.0	6.3	6	76K	96%	93%
6	6.3	6	97K	97%	94%

The layer reporting counts diagonal shifting as failure, even if there are layers.

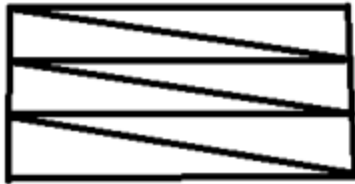

Attempted.

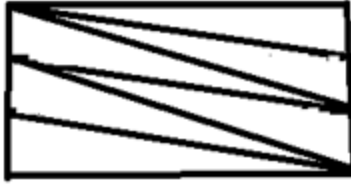

Created. Diagonal shifting counts as failure, even if there are layers.

## Why Use Seeding?

In general, Ansys recommends the use of adaptive meshing. However, in some cases an adaptive solution is not possible. Skin Depth Seeding helps in some of these cases. Additionally, some users demand Skin Depth Seeding for situations in which they create layered structures to force the mesh. This affects the robustness of meshing.

Use of Skin Depth Seeding in appropriate projects is a means to arriving at a converged solution sooner.

In the following figure:

- **Green** – no seeding, no sheets; raw model pure adaptive solution
- **Red** – sheet body version
- **Blue** – new Skin Depth Seeding, but slightly older result; latest result is much better than the blue as shown before

Ohmic Loss Vs number of passes

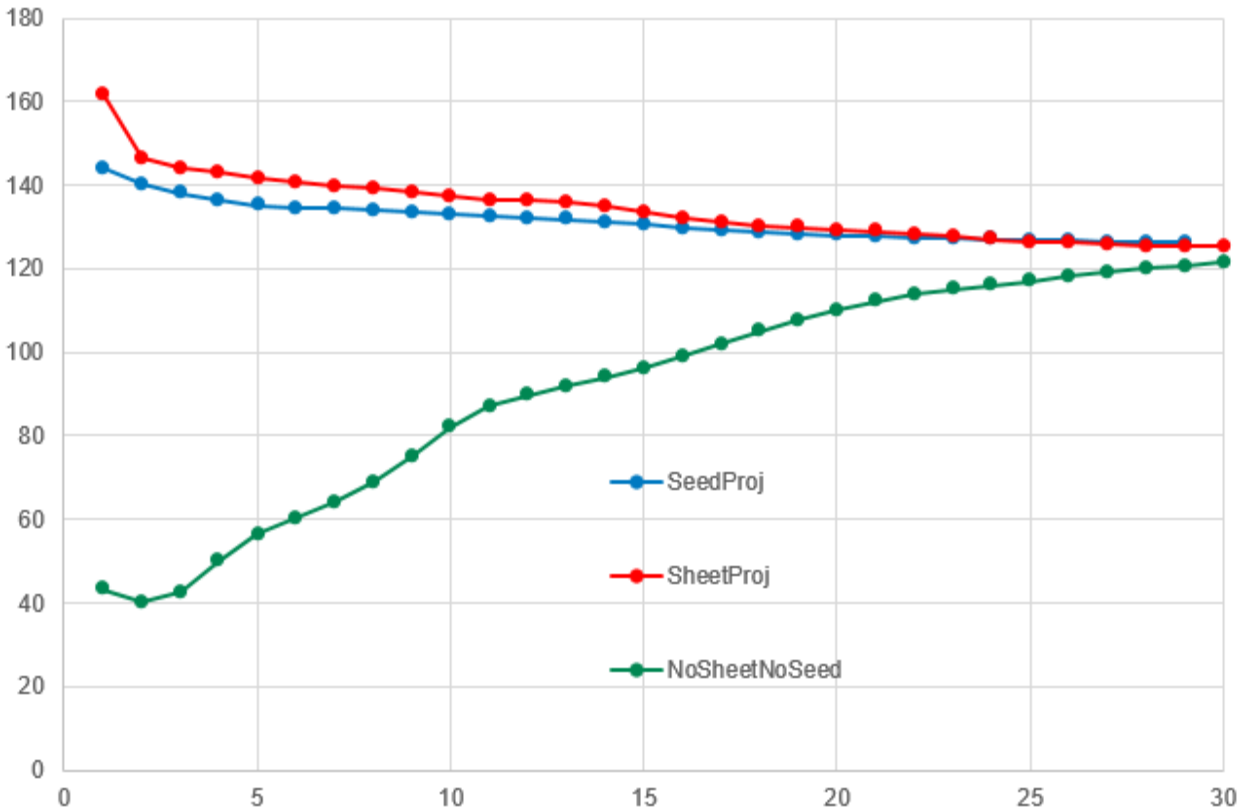

## Skin Depth Seeding Implementation Change

Prior to 2018, Skin Depth Seeding utilized layered points. The current implementation uses layered elements.

**On Selection > Length Based** mesh seeding occurs on the surface. **Inside Selection > Length Based** occurs within the interior volume of the body. These mesh operations do not involve Skin Depth seeding. Compare the results of **On Selection >** and **Inside Selection > Length Based** mesh operations:

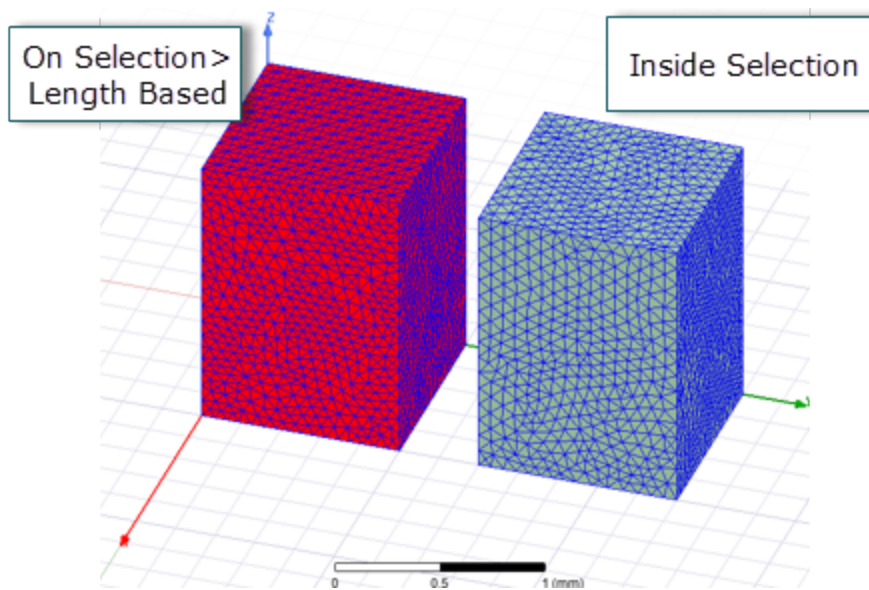

While the surface mesh is similar, the use of a clip plane shows that the interior mesh for Inside Selection is different.

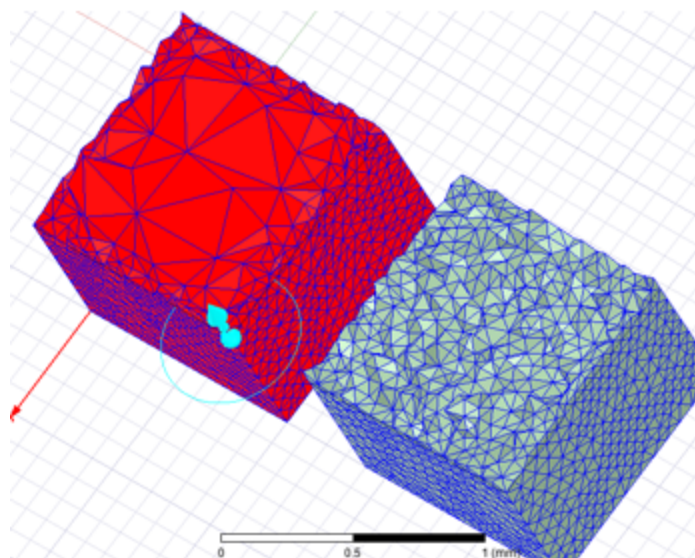

## Layered Elements Implementation

Electronics Desktop requires less layering than other EM tools, and other physics. In contrast with other tools, the Electronics Desktop:

- Does not just look at layered elements
- Pays attention to element count, number of points/elements in the interior

- Offers incredibly small element counts

Layered Elements can be applied to select faces of solid bodies. Elements are stretched parallel to the faces and compressed in the normal direction.

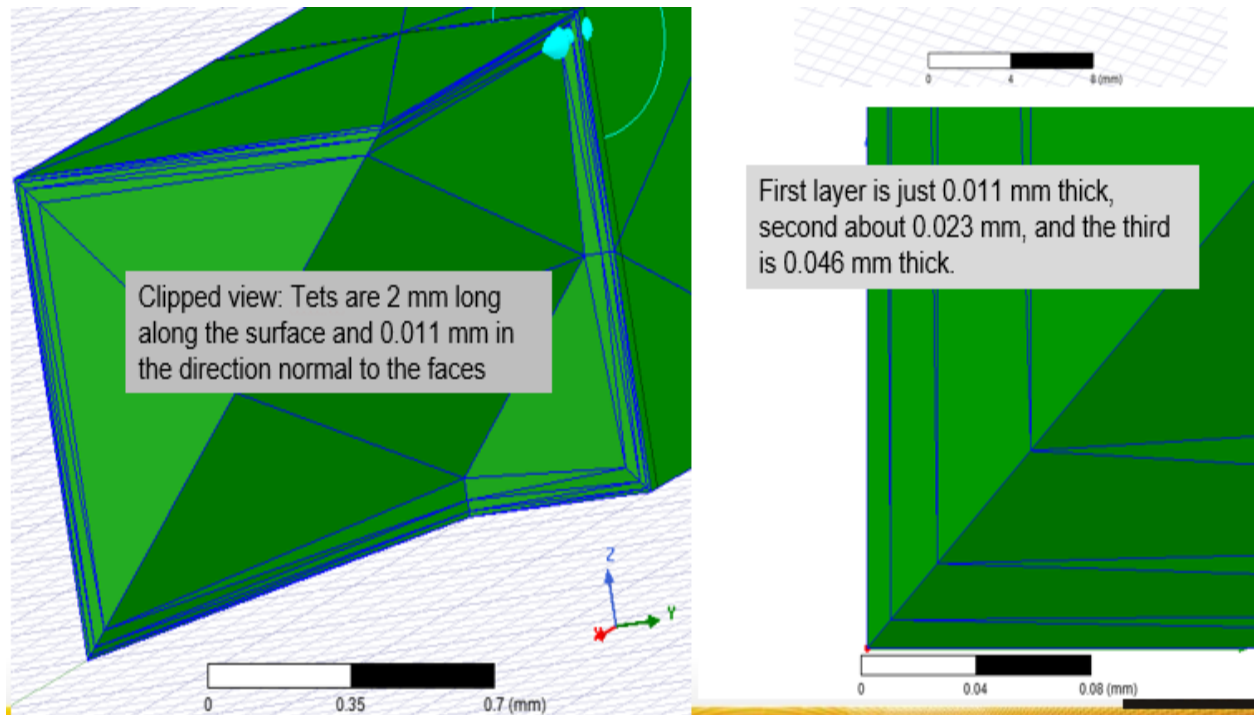

## General Guidance for Skin Depth Based Refinement

To best understand how Skin Depth refinement works, experiment with simple models to understand refinement behavior. You can test bodies with skin depth seeding in isolation using scratch projects.

Particularly for models with true curved surfaces (for example, true cylinders), the *Curved Surface Meshing* setting has a large impact on the layering success rate. To change this or other settings, right-click **Mesh** in the Project Manager and select **Initial Mesh Settings**.

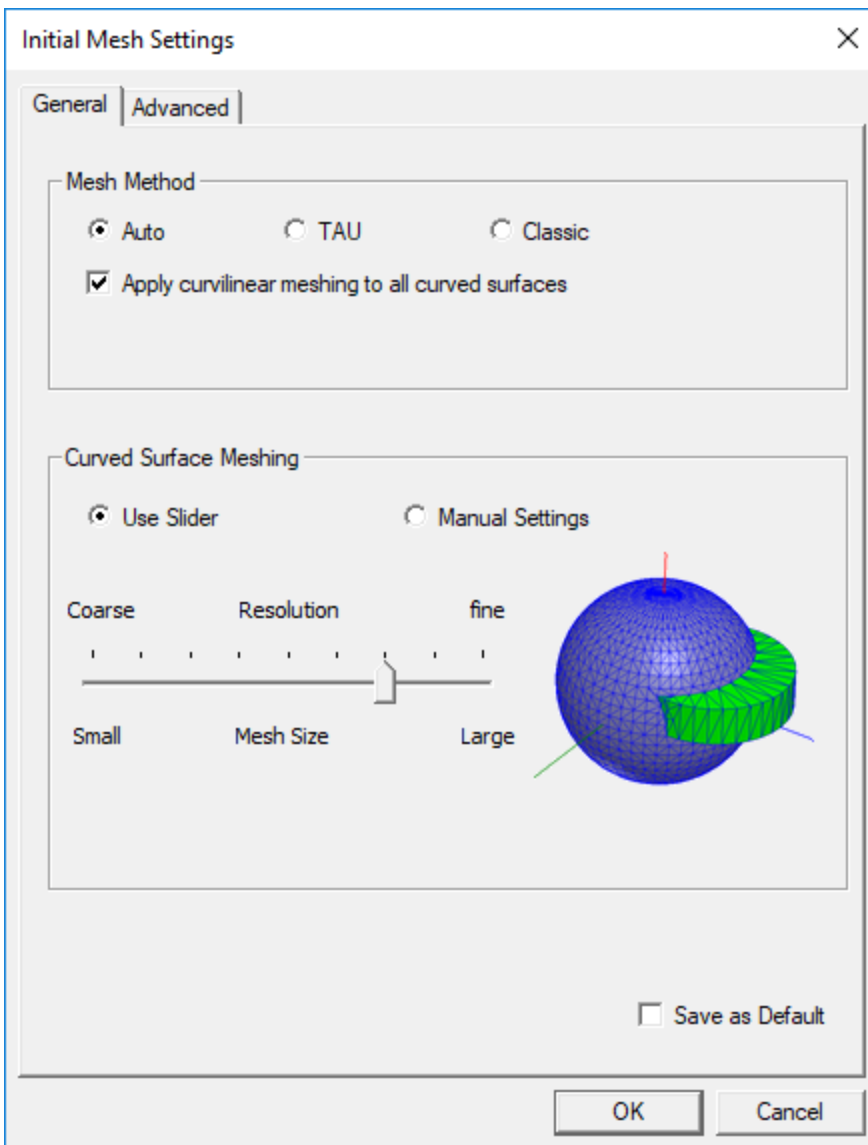

Selecting a very coarse initial mesh results in a low (60%) success rate. Finer meshes easily hit 80%, surging to 95%.

For example, the following figure shows a faceted cylinder with triangles and segments on a face. The open triangles show imperfect layering, but a very good success rate.

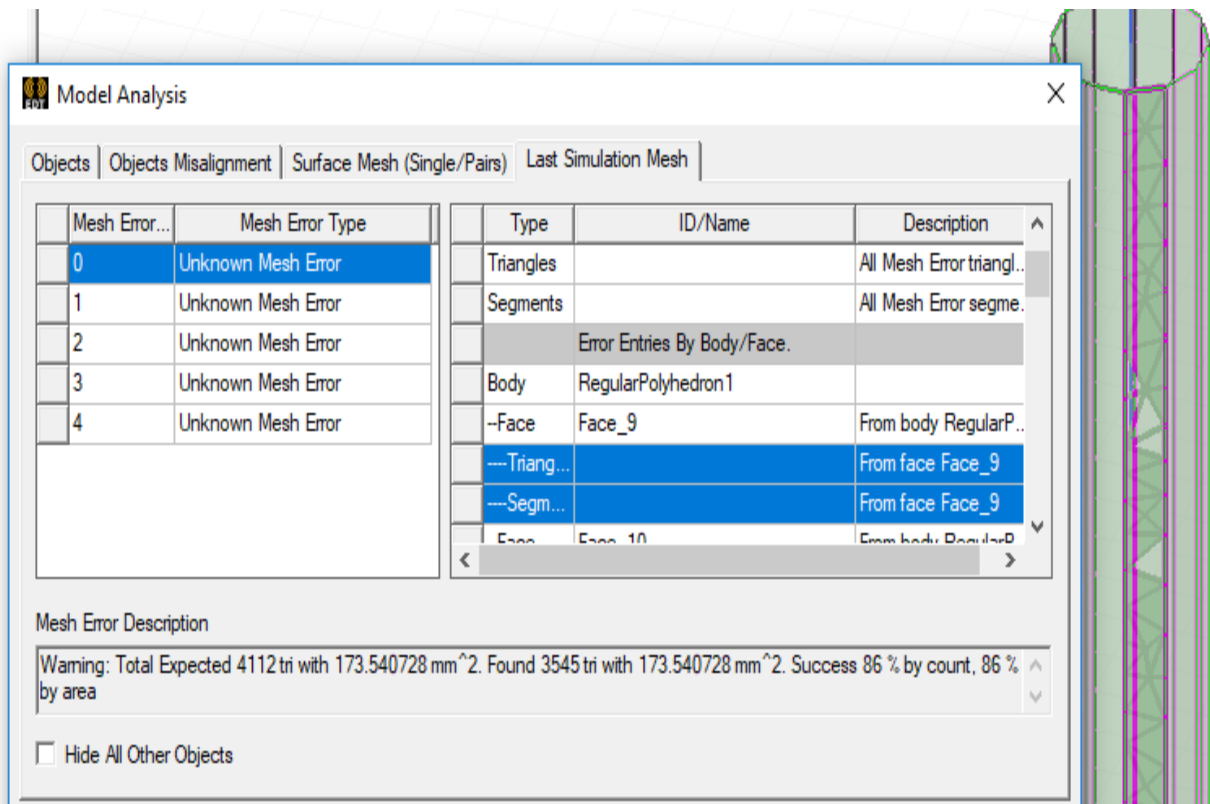

A true cylinder with similar mesh settings (including a medium resolution for curved surface meshing) shows a lower success rate.

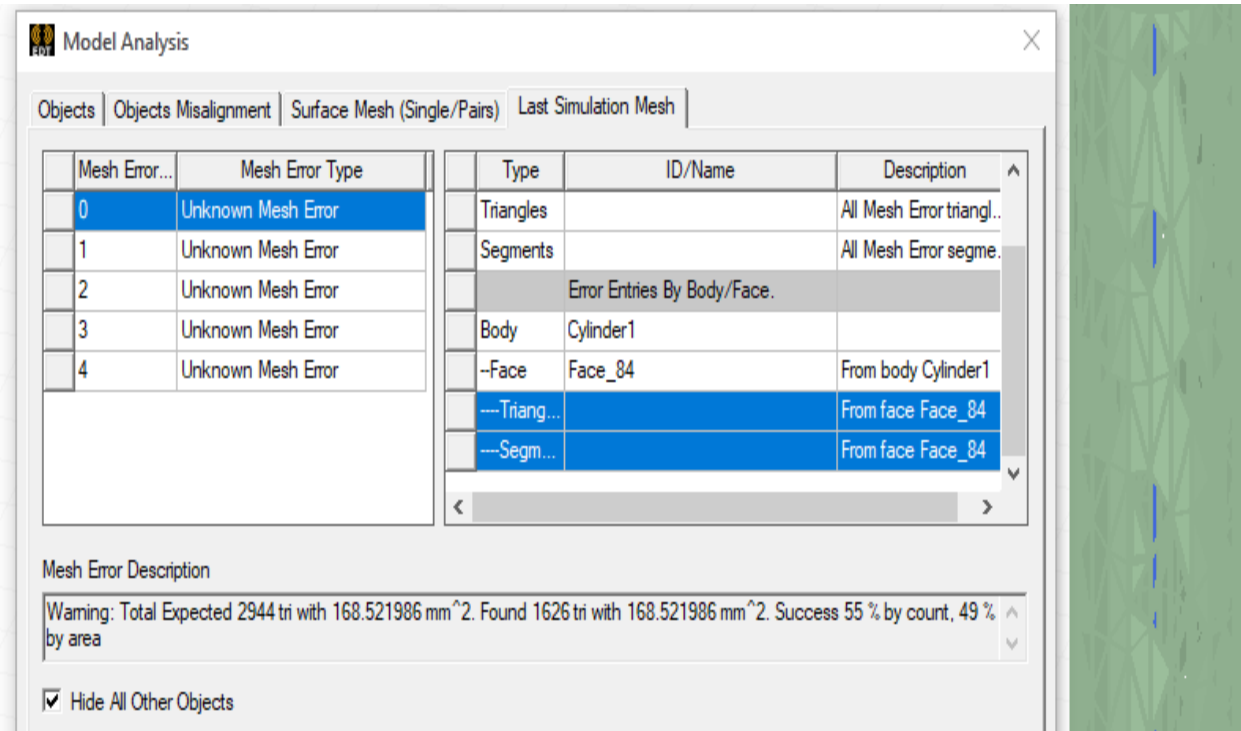

Moving the slider two ticks to the right improves the success rate for the true cylinder much more effectively than a change to *Skin Depth Refinement* would. In this case, the overall success goes from 55% to 81%.

Note that the different layers, 0 through 4 in this example, will have different success rates.

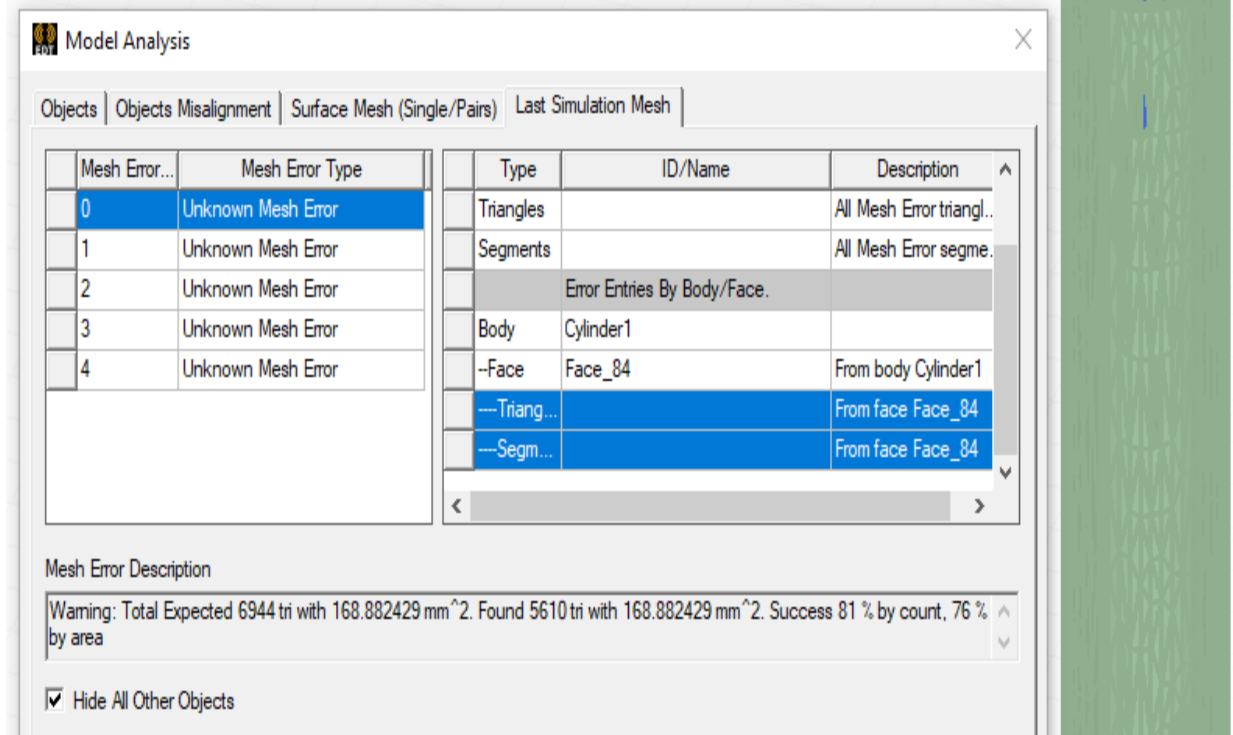

In addition to the options in the *Initial Mesh Settings* dialog box, you can use *Skin Depth Based Refinement* settings to reach a suitable success rate supporting a good solution. To access these options, right-click **Mesh** in the Project Manager and select **Assign Mesh Operation > On Selection > Skin Depth Based**.

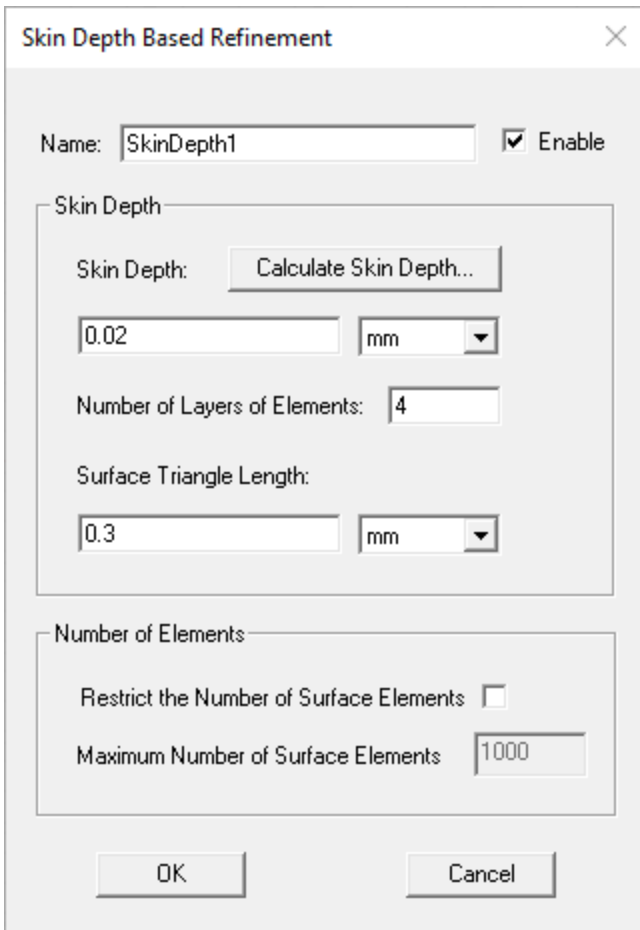

Reduce **Surface Triangle Length** target to improve layering success rate, where success is consistent layering.

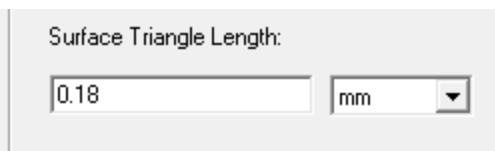

Consider the Surface Triangle Length to Mean Skin Depth ratio. For guidance:

- Avoid stretched triangles on the surface
- Get a few points on the interior of faces
- Test a wide range of ratios from 2.5 to 800
- Set a ratio of 100 or above to contribute to a good success rate
- Above 800, mesh tolerance Quality issues come in to play

Remember that layered meshing is the means to a solution, not the end goal. Layering elements is one way to get a good solution. Always check the correctness and accuracy of solutions.

## Guidance for HFSS for Skin Depth Based Refinement

- For conducting material, you must enable **Solve Inside** or the feature has no effect.
- Some spiral inductors might obtain a better Q value when **Solve Inside** is enabled.
- For projects where you solve inside conductors, there may be a subset of models that benefit.

## User Inputs for Skin Depth Based Refinement

For Skin Depth Based refinement to have an effect, the **Solve Inside** property for the selected 3D object's material must be checked.



Select the faces of the solid body to which you want to apply Skin Depth Based refinement, and right-click **Mesh** in the Project Manager. Select **Assign Mesh Operation > On Selection > Skin Depth Based...** to display the *Skin Depth Based Refinement* dialog box.

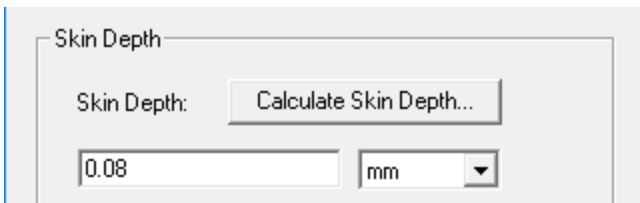

The Skin Depth is the total depth of all layers combined. Very thin layers may cause a reduction in mesh quality or unnecessarily cause the generation of a very large mesh. Further regions refined under this operation and its close neighbors do not participate in solution adaptive refinement. This is another reason to use this seeding operation with caution.

To calculate the skin depth based on the object's material permeability and conductivity and the frequency at which the mesh will be refined, click **Calculate Skin Depth...**

The *Calculate Skin* depth dialog box appears.

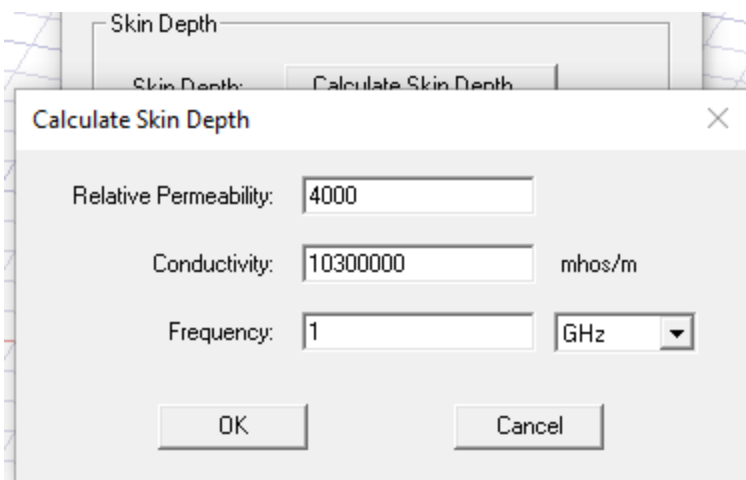

Initial values for Relative Permeability and Conductivity are taken from the Materials library. For HFSS, the Frequency value is taken from the *Solution Setup*.

**Note:**

All three values must be non-zero to obtain a calculated value using this feature.

When you click **OK**, the *Calculate Skin Depth* dialog box disappears and the calculated value appears in the Skin Depth field of the *Skin Depth Based Refinement* dialog box.

**Note:**

You can edit the calculated value or provide your own without using calculation. Check whether the calculated value is appropriate to fit within the dimensions of the object.

Next, specify a **Number of Layers of Elements**.



For the number of layers, choose 2, 3, 4 or (at most) 5 layers. First layer thickness =  $1/(2^{n-1}) = 0.333, 0.143, 0.0667, 0.0322$ . The elements are stretched parallel to face, and are compressed in the normal direction.

Optionally, provide the maximum edge length of the surface mesh in the **Surface Triangle Length** text box. The default value is set to 20% of the maximum edge lengths of the bounding boxes of each selected face.

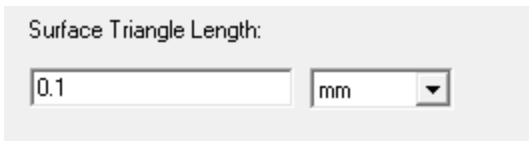

The solver will refine the surface triangle mesh (the faces of the tetrahedra touching the surface) until their edge lengths are less than or equal to the specified value.

By default, the **Restrict Number of Surface Elements** setting is cleared. This allows the mesher to use symmetry more effectively. If you restrict the number of surface elements, symmetry may be affected. However, in certain cases, you can restrict the number of surface elements to prevent runaway refinement.

To restrict the number of elements added during refinement of the faces, first observe the estimated number of surface elements in the *Maximum Number of Surface Elements* text box. Then, select the **Restrict Number of Surface Elements** option to enable the **Maximum Number of Surface Elements** option. Adjust the specified number of surface elements as desired.

#### Note:

You cannot edit the *Maximum Number of Surface Elements*, and the specified number has no effect on the resulting mesh, until you select the *Restrict Number of Surface Elements* option immediately above it.

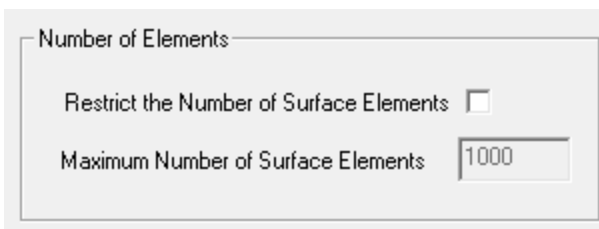

When the mesh is generated, the refinement criteria you specify are used. This operation is approximately the same as having slabs of tetrahedra, but it is not guaranteed to prevent tetrahedra from crossing slab interfaces. Use caution with this mesh operation, as very thin layers may cause a reduction in mesh quality or unnecessarily cause the generation of a very large mesh. Further regions refined under this operation and its close neighbors do not participate in solution adaptive refinement. This is another reason to use this seeding operation with caution.

## Generate Initial Mesh

After defining mesh operations for a model (including **Initial Mesh Settings**, **Skin Depth Based**, or other operations), you can generate an initial mesh without solving the analysis. To do so, right-click **Analysis** in the Project Manager and choose **Generate Mesh** from the shortcut menu.

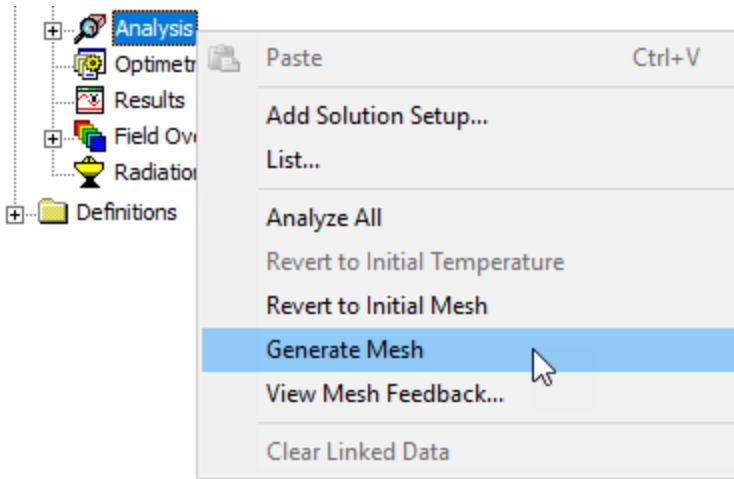

After generating a mesh, you can overlay mesh plots and use the **Cut Plane** features to examine the appearance of the mesh. Also, right-click **Analysis** in the Project Manager and choose **View Mesh Feedback** to access the **Mesh Feedback** tab of the *Model Analysis*. Here, you can evaluate the success of the mesh and view any problems. The **Mesh Error Description** box on this tab provides a statistical evaluation of the overall body's meshing success (expected versus found triangles) as well as success percentages by count and by area.

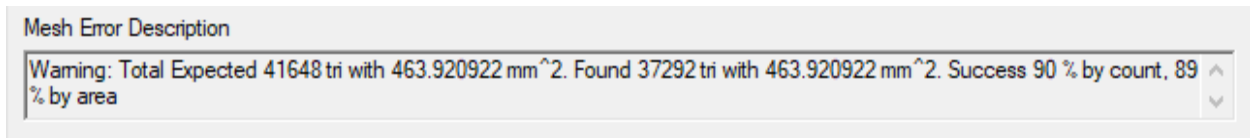

## 2 - Skin Depth Mesh Plot Visualization

The Modeler provides two ways to visualize meshes:

- Mesh plots and Clip Planes
- The *Mesh Feedback* tab of the *Model Analysis* window, which also provides statistics

After generating a mesh, you can create a mesh plot that you can examine using a Clip Plane to view internal mesh features.

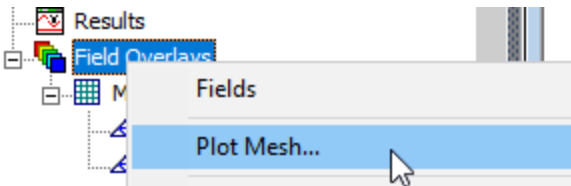

If you did not select the end faces for layers, and if they are at 90 degrees to the selected faces, you can see some layering in the surface mesh plot.

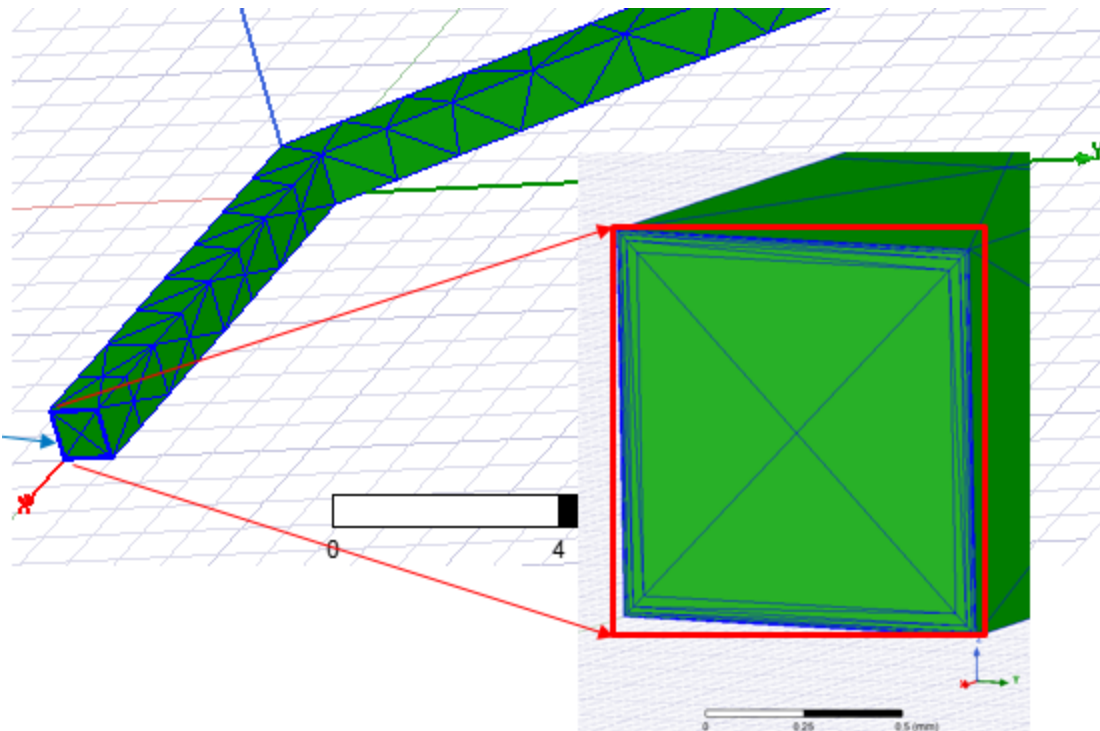

In some cases, the state of the surface mesh may not indicate the quality of the internal mesh. Consider an example where layering is very good on the bent faces, but imperfect on the side faces due to swapped diagonals.

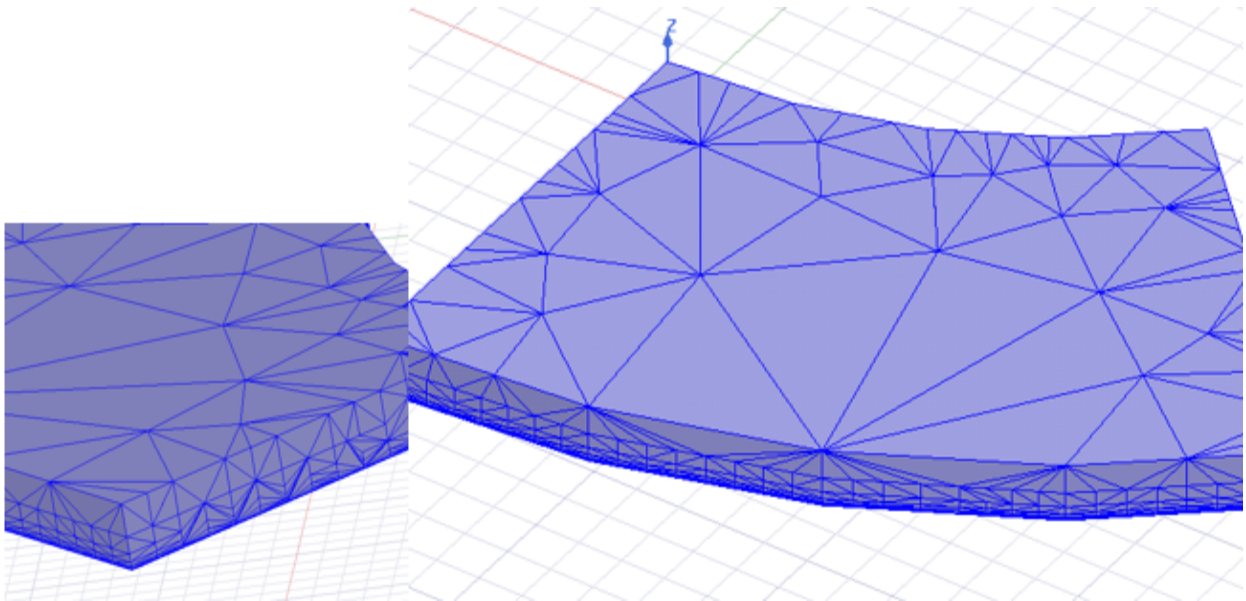

The following figure shows a closer look at a side face, showing the swapped diagonals that occurred in this case.

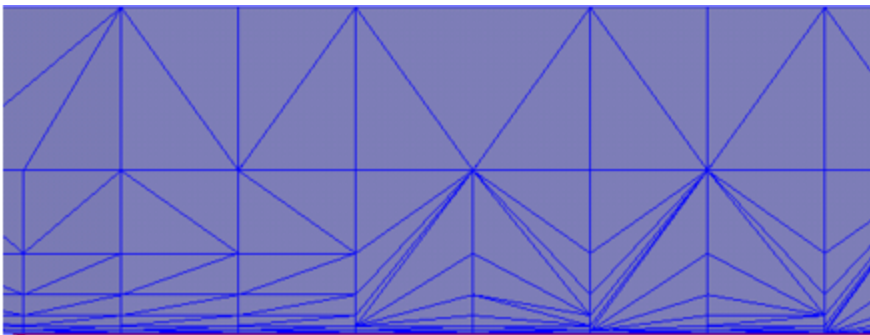

A view of the internal layering shows the quality of the overall mesh.

95% of the triangles have perfect layering.

Layering is not as good near the edges.

Filled triangles show where we achieved perfect layering.

Open triangles show where we wanted layering, but did not get it.

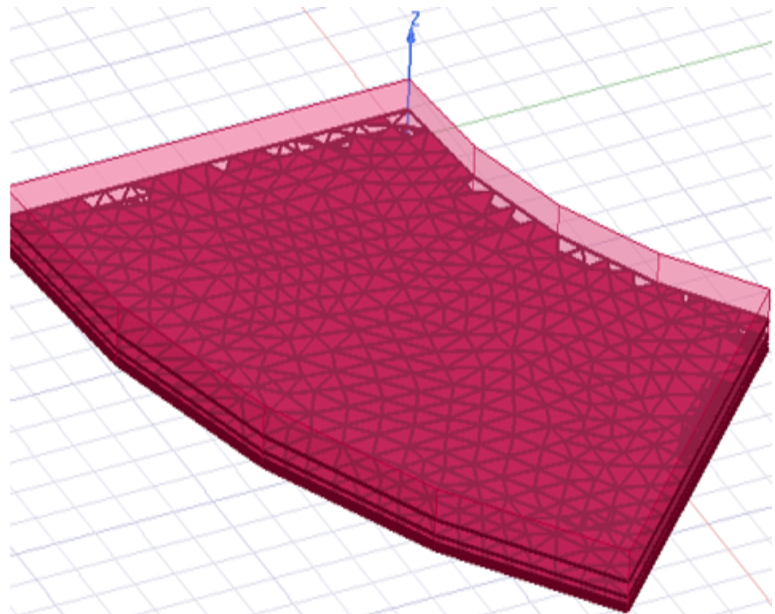

For the settings used, the mesh is identical across layers for 95% of the area. Changes to settings can improve the success rate, but a 100% success rate is *not required* for a good solution and is not desirable in all cases because it could cause a very large mesh and labored simulation. Note the different success rates based on different **Surface Triangle Length** in this example:

Tri length target mm	Total skin depth mm	Number of layers	Mesh Size element count	Perfect layering by tri count	Perfect layering by area
15.0	6.3	6	63K	43%	65%
10.0	6.3	6	68K	95%	94%
8.0	6.3	6	76K	96%	93%
6	6.3	6	97K	97%	94%

The statistics for success come from the *Mesh Error Description* field of the *Model Analysis* window, shown below.

Mesh Error Description

Warning: Total Expected 41648 tri with 463.920922 mm<sup>2</sup>. Found 37292 tri with 463.920922 mm<sup>2</sup>. Success 90 % by count, 89 % by area

## Using a Clip Plane to View the Internal Mesh

You can also use the **Clipping Planes** feature on the **View** tab of the ribbon (see below) or the **View > Clipping > Clip Plane** menu command to view the internal details of a mesh.

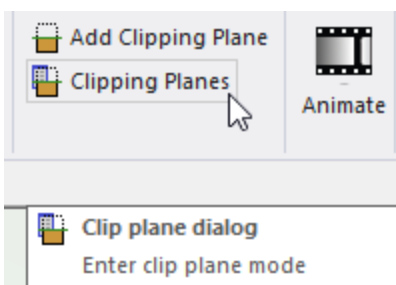

After you have created a solution:

1. Select a face of the model.
2. Open the **Clip Planes** window and click **Add > Use Selection**.

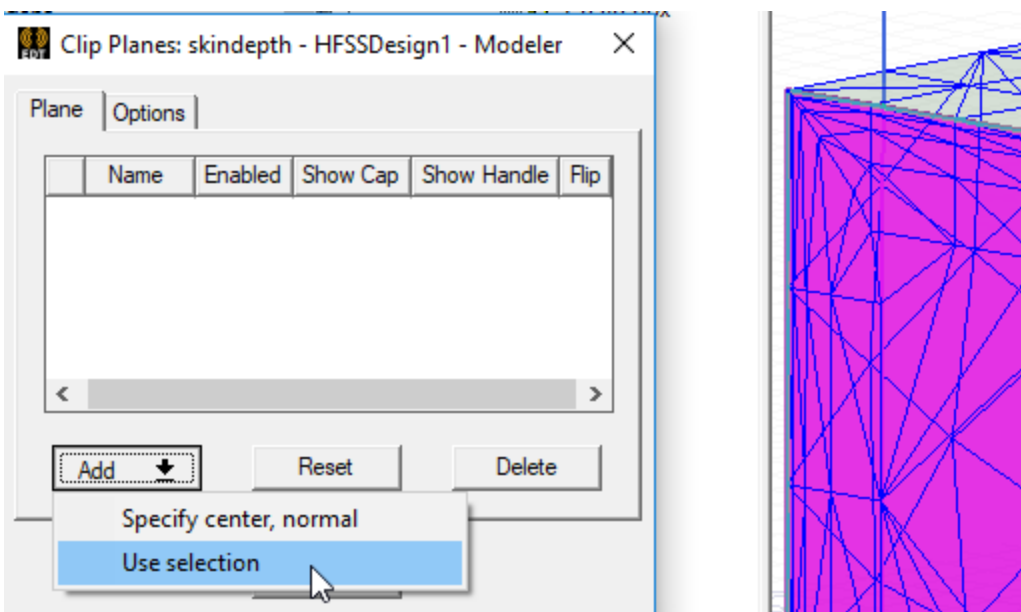

The window shows a defined and enabled clip plane, and the handle is visible as a circle, center sphere, and direction cones.

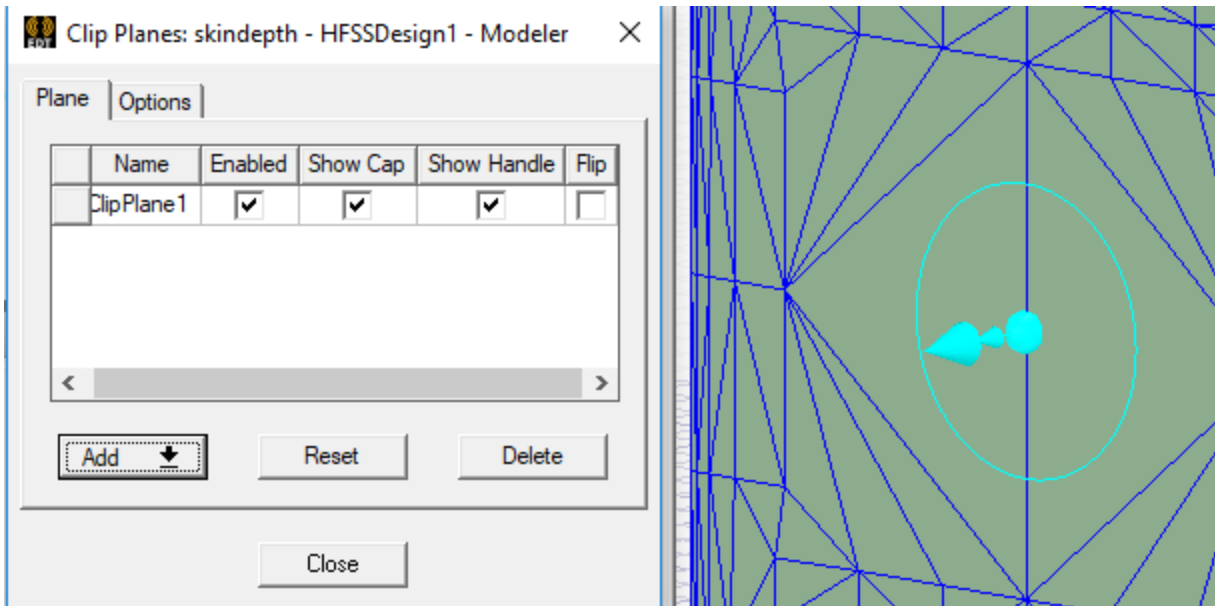

The handle may obscure your view of the internal mesh. If this happens, move the clip pane to the side of the object by performing the following steps:

1. Click the edge of the center circle until you see four green direction arrows.

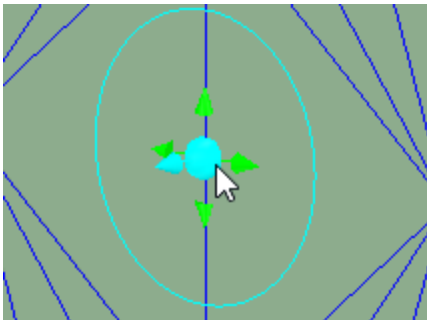

2. Click and drag the handle to the right until it is past the face of the object.

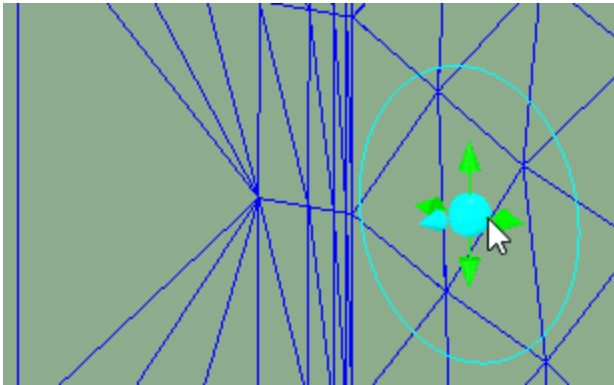

3. To use the clip plane handle, point the cursor at the center of the inner circle until the cone turns yellow (If the cursor is not at the center, the cone does not change, and four green direction arrows appear around the inner circle).

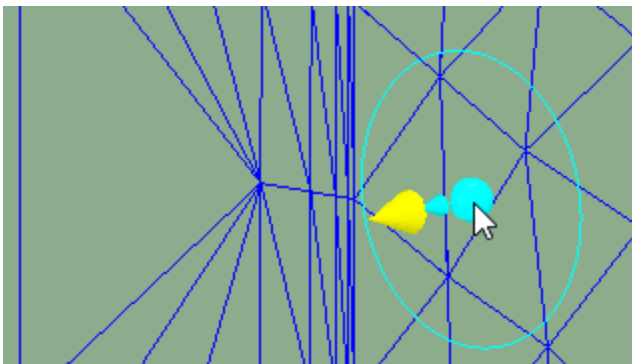

From here you can click and drag the clip plane to the right, and watch the clip plane move through the object, revealing the detail of the inner mesh.

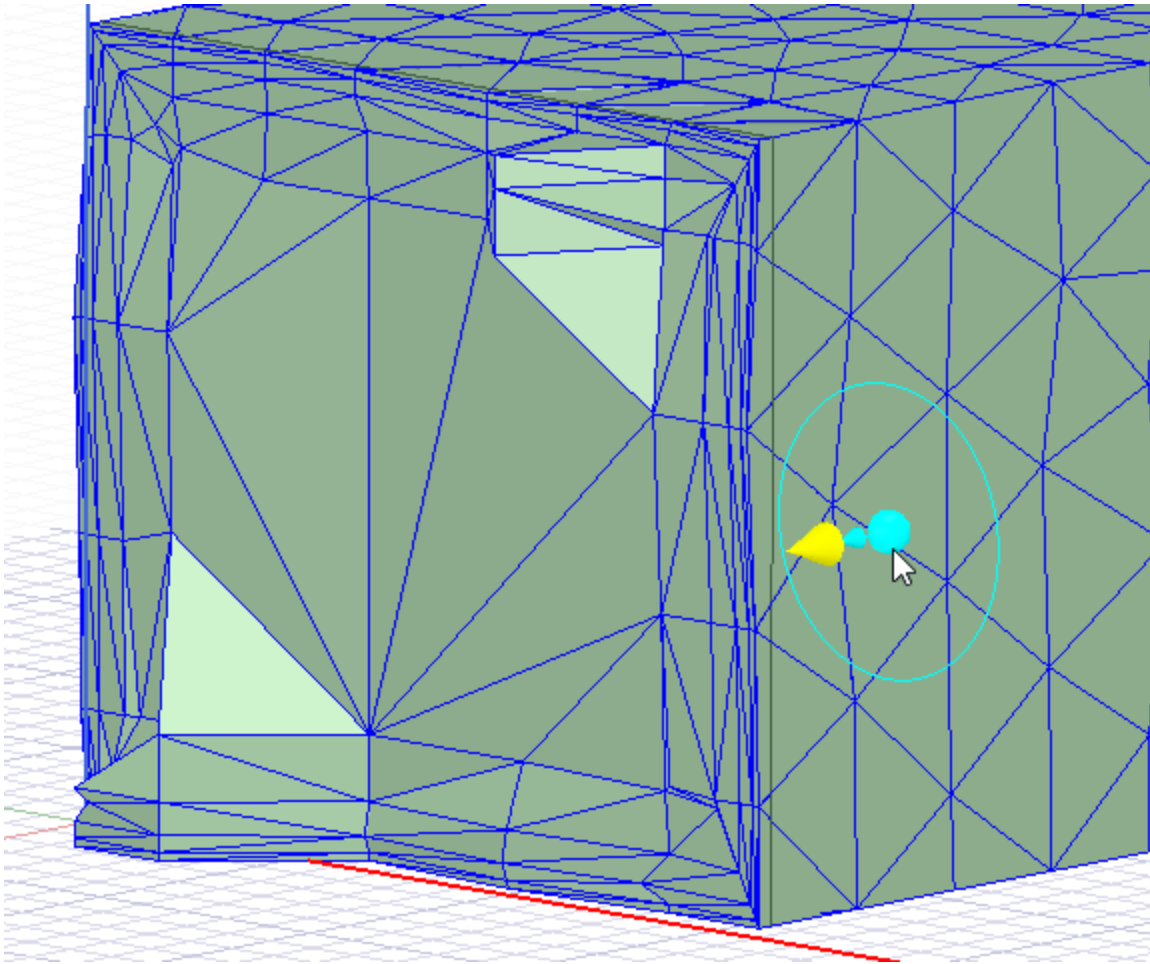

A Clip plane can be revealing and insightful but can be difficult to use. Clip plane views can also be misleading when the plane exposes partial tets at odd locations and makes a good mesh look bad. Alternatively, you can view mesh data using the *Model Analysis* window.

## Viewing Mesh Feedback to Critique the Internal Mesh

When viewing mesh feedback, do not enable a mesh plot display. After running the **Analysis** or clicking **Generate Mesh** (in the *Analysis* shortcut menu), you can right-click **Analysis** in the Project Manager and choose **View Mesh Feedback** to open the *Model Analysis* window. If errors occurred during mesh generation, they are listed under the *Mesh Feedback* tab of this window.

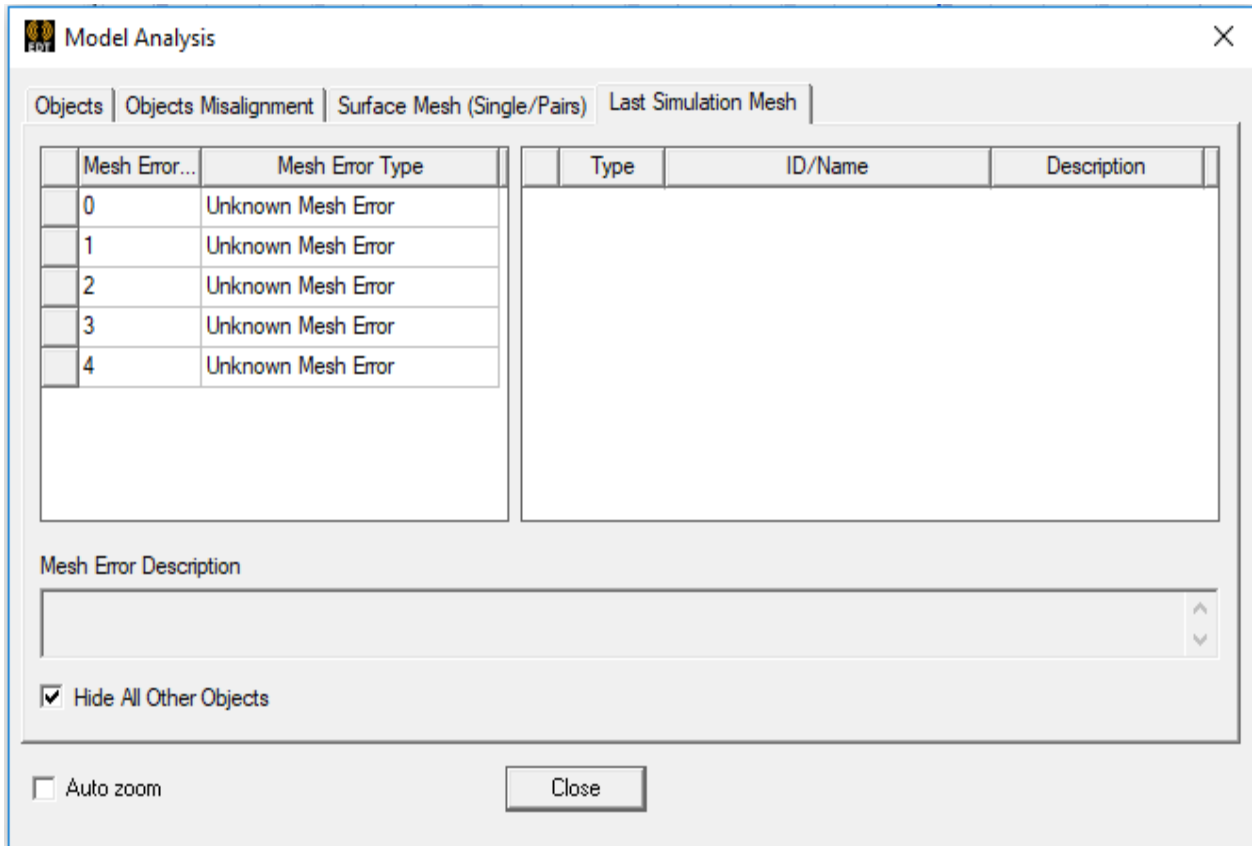

Select a *Mesh Error* row from the left panel to populate the right panel with face, triangle, and segment information.

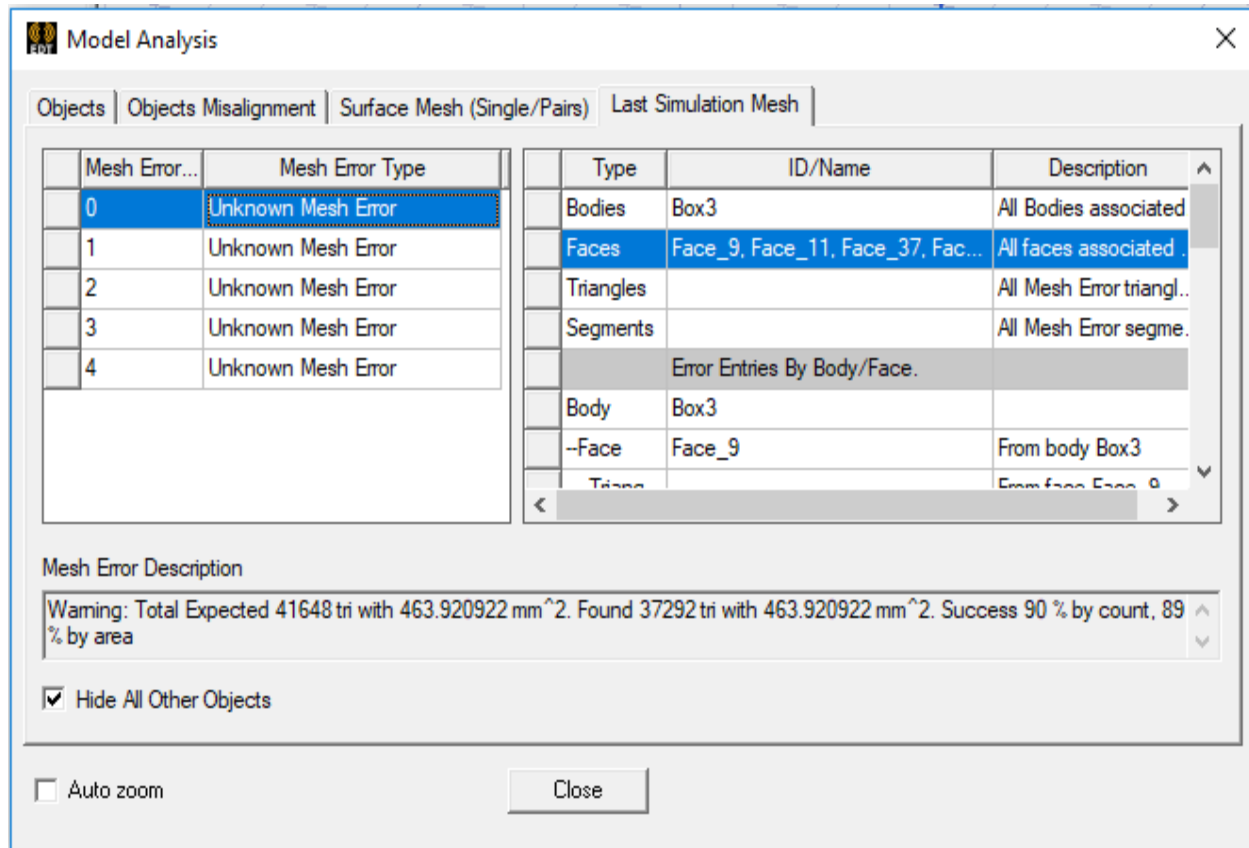

Row 0 on the left shows the face to which Mesh Layering has been assigned. Layer 1 is closest to the Face. Layer  $n$  is farthest. The initial selection on the right side is a comma separated face list for all faces associated with the body.

The **Mesh Error Description** box describes the results of the simulation for the selected layer. The first part lists the *Total Expected* number of triangles of a given area compared with the total number of *Found* triangles. This is followed by the *Success* percentages by count and by area.

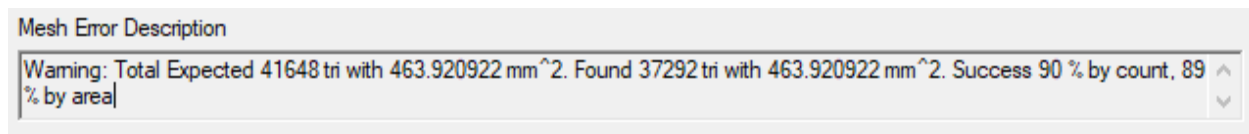

The selected layer row for the left panel affects the Mesh Error Description fields, showing the results for the selected layer.

Mesh Error...	Mesh Error Type	Type	ID/Name	Description
0	Unknown Mesh Error	Bodies	Box3	All Bodies associated
1	Unknown Mesh Error	Faces	Face_9, Face_11, Face_37, Fac...	All faces associated
2	Unknown Mesh Error	Triangles		All Mesh Error triangl..
3	Unknown Mesh Error	Segments		All Mesh Error segme..
4	Unknown Mesh Error			
Error Entries By Body/Face.				
		Body	Box3	
		--Face	Face_9	From body Box3
		Triang		From face Face_9

Mesh Error Description

Warning: Layer 4 NLayers= 4 Expected 10412 tri with 115.059677 mm<sup>2</sup>. Found 8098 tri with 89.200269 mm<sup>2</sup>. Success 78 % by count, 78 % by area

## Selecting and Viewing Specific Faces

When you select a layer in the Mesh Error panel, a comma-separated list of the associated faces with mesh errors is selected (highlighted) in the right side panel.

Bodies	Box3	All Bodies associated
Faces	Face_9, Face_11, Face_37, Fac...	All faces associated
Triangles		All Mesh Error triangl..

The *Modeler* window shows all the selected faces. Zoom in to see the individual yellow Mesh Warning triangles comprising the yellow areas.

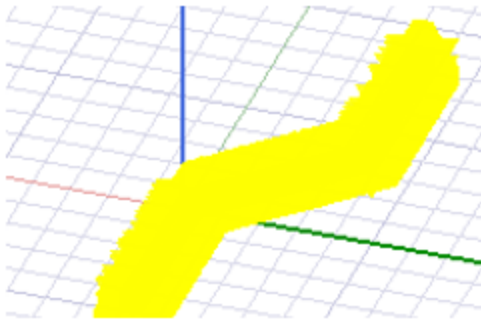

Initial View with  
Yellow Warnings

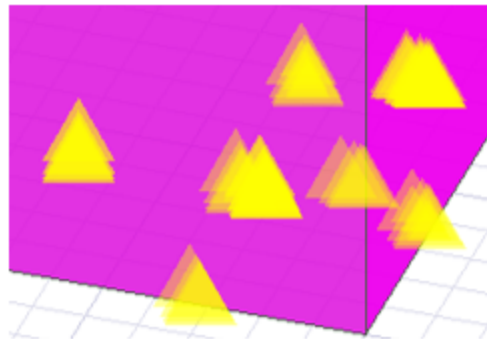

Zoom to Show Yellow  
Warning Triangles

Subsequent rows in the Mesh Error Panel list error entries by body or face for the selected layer. If the number of faces for the model is too large to fit the pane, you can resize the window and/or use the scroll bar. As shown below, selecting a body or face row in the *Model Analysis* window also selects the corresponding body or face in the *Modeler* window.

Type	ID/Name	Description
---Segm...		From face Face_67
--Face	Face_68	From body Box3
---Triang...		From face Face_68
---Segm...		From face Face_68
--Face	Face_70	From body Box3
---Triang...		From face Face_70
---Segm...		From face Face_70

mm<sup>2</sup>. Found 37292 tri with 463.920922 mm<sup>2</sup>. Success 90 % by count, 89

Close

 A 3D wireframe model of a rectangular block is shown on a grid. One of the faces, Face\_70, is highlighted in blue, corresponding to the selection in the table above. The rest of the model is in a light green color.

You can enable or disable the **Hide All Other Objects** and **Auto zoom** features as needed.

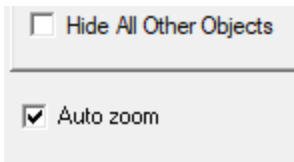

### Selecting Triangles for a Face

Selecting **Triangles** from the row under the associated Face selects the triangles on that face.

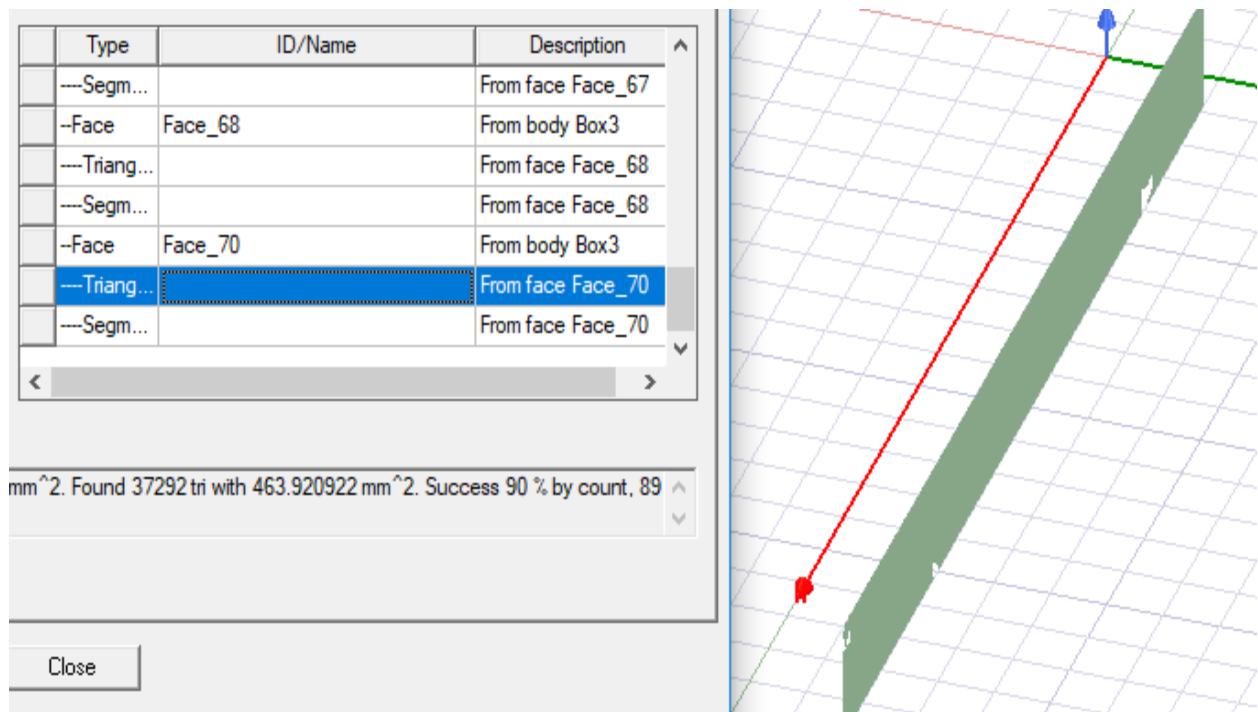

Triangles that have errors are not colored in. Remember that a good solution using skin depth mesh operations does not require perfection.

### Selecting Segments for a Face

Selecting **Segments** associated with a Face displays the corresponding segments in the *Modeler* window.

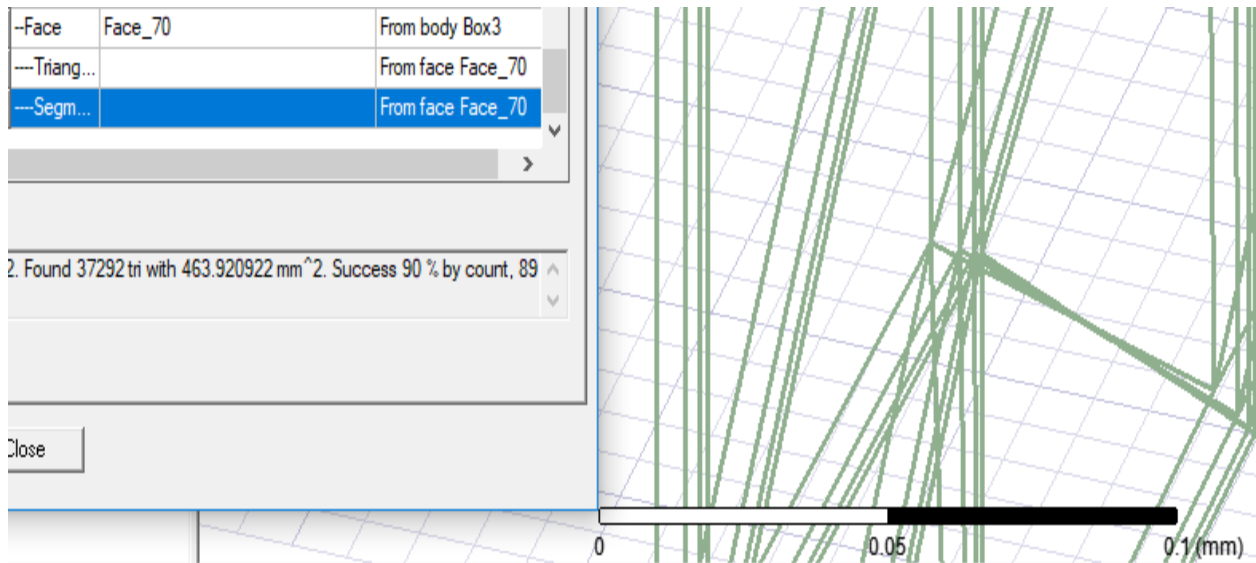

## Viewing Triangles and Segments at the Same Time

Using **Shift+click** or **Ctrl+click**, you can select both triangle and segment rows for the most informative display. Triangles associated with imperfect layering are not colored in.

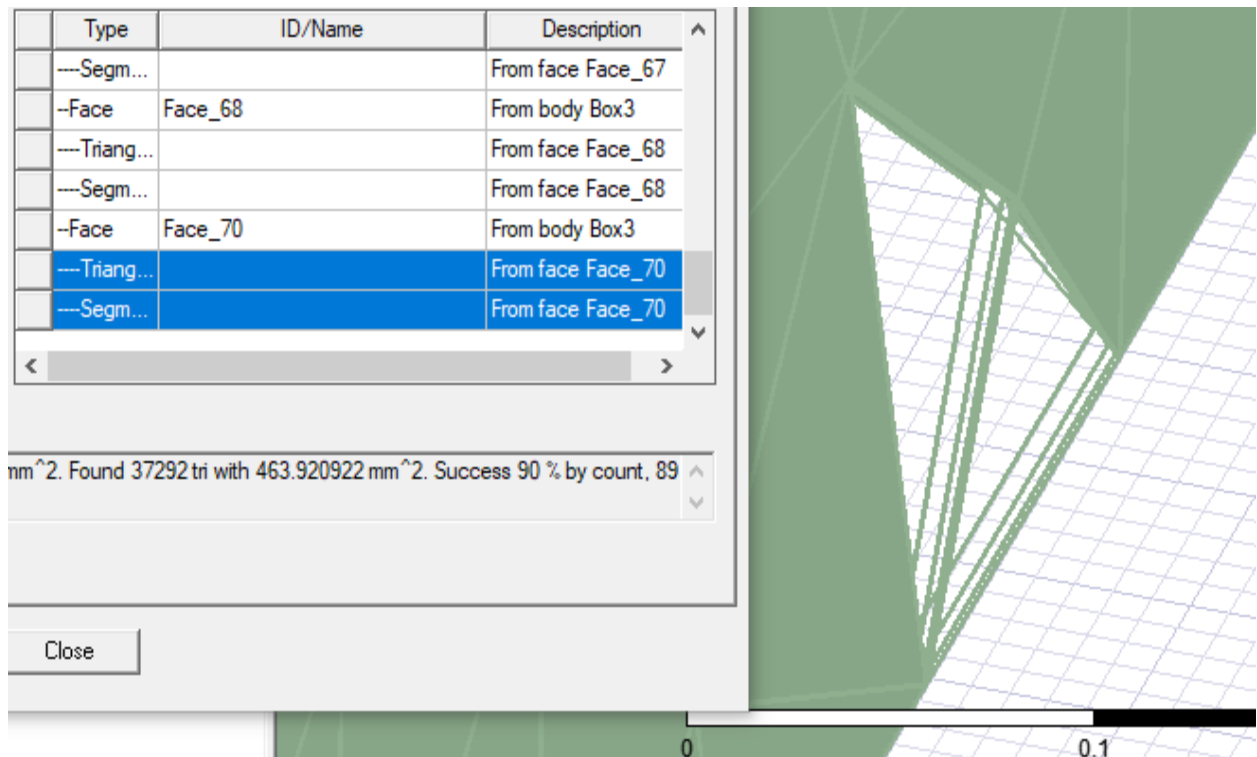

You can use the **Zoom**, **Pan**, and **Rotate** commands on the View ribbon to look closely at specific areas.

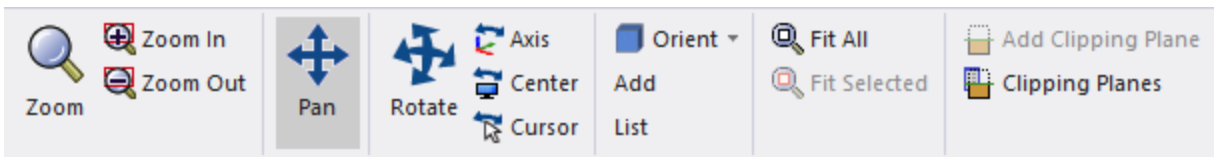

## Changing Settings in Response to Success Rates and Visualization

Once you have examined the results, you can change the **Initial Mesh Settings** and **Skin Depth Refinement** values to improve the success rate to a suitable result. You can then right-click **Analysis** in the Project Manager and click **Generate Mesh** to update the mesh. Then, view and evaluate the effects of the revised settings on the overall success of the mesh.